

AC Drive System

# TMdrive™ -MVe2 series



Energy Saving Medium Voltage Inverter

# TMdrive-MVe2 *series*



easy

eco

## **Saving Electric Power and Minimizing Peripheral Equipment**

Peripheral equipment is reduced by Static Var Compensation. The TMdrive-MVe2 has a very small footprint and height, that allows for economical transportation and installation.

## **Improved Productivity**

Regenerative Braking is standard.  
Fast acceleration/deceleration operations are available.  
Under sensorless vector control, fast response and stable operations are available.

## **Energy Saving**

Application of an inverter saves energy. In addition, the TMdrive-MVe2 has high efficiency.

## **Power Supply Friendly**

The TMdrive-MVe2 has very low harmonic levels and low inrush currents.

The high input power factor contributes to an electricity cost reduction and a smaller power supply requirement for on-site power generation.

## **Simple Commissioning, Operation and Troubleshooting**

The Auto-tune function assists with a shorter commissioning period. Central control of multiple inverters can be performed easily with accuracy.

# TMdrive -MVe2 series



## CONTENTS

---

• Product Introduction	
Saving Electric Power and Minimizing Peripheral Equipment .....	P.3
Improved Productivity .....	P.6
Energy Saving .....	P.7
Power Supply Friendly .....	P.9
Simple Commissioning, Operation and Troubleshooting .....	P.10
<hr/>	
• Circuit Configuration	P.11
<hr/>	
• Standard Specifications	P.13
<hr/>	
• Outline Dimensions	P.19
<hr/>	

# Product Introduction

## Saving Electric Power and Minimizing Peripheral Equipment

### Static Var Compensation

Leading/Lagging reactive power is controlled by Static Var Compensation. Utility reactive power is quickly and stability minimized by this system.

#### Minimizing peripheral equipment

Initial cost reduction and space-saving are realized by minimizing phase advance capacitor and receiving transformer capacity. Static Var Compensation is possible with max 70% capacity of inverter capacity.

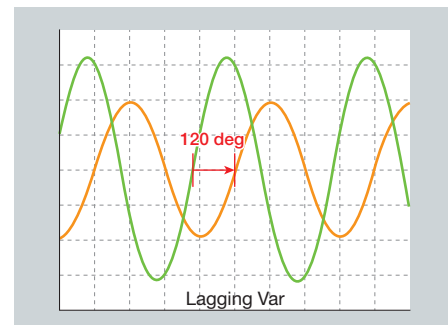
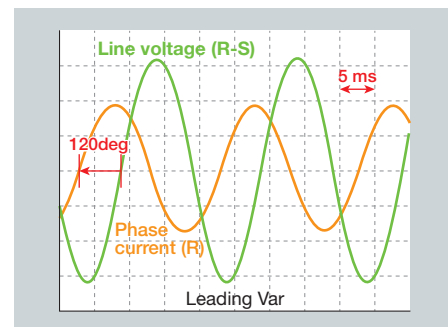
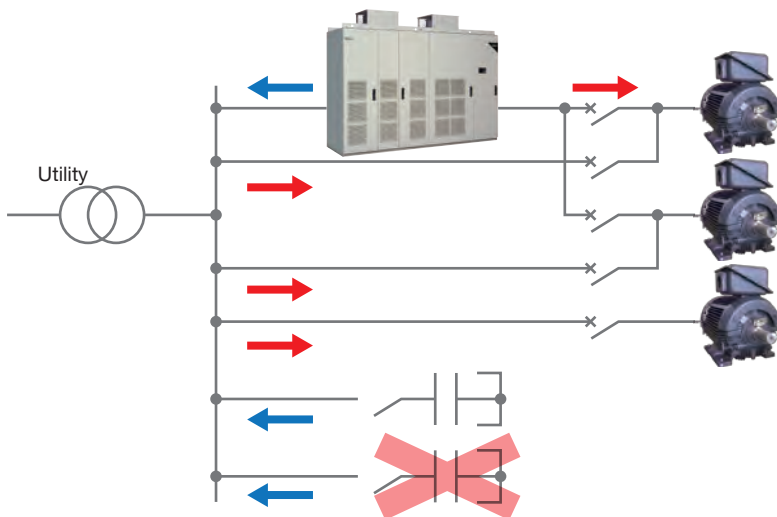

#### Various connection methods

To input the feedback signal for Static Var Compensation

##### (1) From PLC

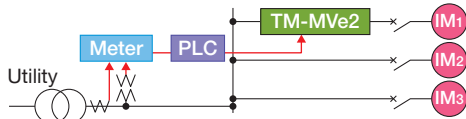

##### (2) From Reactive power meter / power factor meter

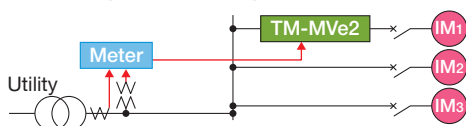

##### (3) From CT and VT directly

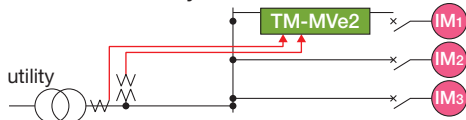

#### Electric charges reduction

Preferential electric power charge are applied (P.F. > 0.85).

Basic charge =

Basic price per unit price × Contract power × (1.85 – P.F.)

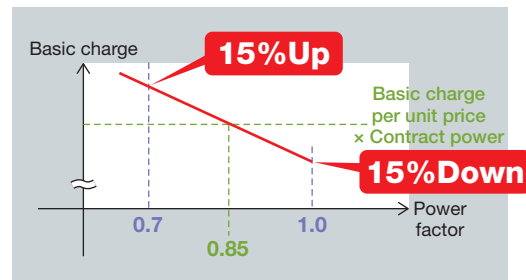

The above is example in Japan.  
Price system is depended on the country.

## Reactive power compensation amount by Static Var Compensation

Following reactive power [kVar] can be supplied depend on inverter capacity [kVA] and motor power [kW].

Inverter capacity [kVA]	Motor output [kW] (Eff. = 0.95)												
	160	320	650	1000	1250	1420	1600	1800	2250	2600	3150	3550	4000
400	200	-	-	-	-	-	-	-	-	-	-	-	-
800	500	400	-	-	-	-	-	-	-	-	-	-	-
1200	800	700	400	-	-	-	-	-	-	-	-	-	-
1600	1100	1000	800	300	-	-	-	-	-	-	-	-	-
1900	1300	1200	1100	800	100	-	-	-	-	-	-	-	-
2200	1500	1500	1300	1100	800	300	-	-	-	-	-	-	-
2600	1800	1700	1600	1400	1200	1000	600	-	-	-	-	-	-
3000	2000	2000	1900	1800	1600	1400	1200	900	-	-	-	-	-
3600	2500	2400	2400	2200	2100	2000	1800	1600	800	-	-	-	-
4400	3000	3000	3000	2800	2700	2600	2500	2400	1900	1400	-	-	-
5000	3400	3400	3400	3300	3200	3100	3000	2900	2500	2100	1100	-	-
6000	4100	4100	4100	4000	3900	3900	3800	3700	3400	3100	2500	1900	-
7350	5100	5100	5000	5000	4900	4900	4800	4700	4500	4300	3900	3500	2900

\* Above table is rough estimation. Please contact our sales staff about actual compensation amount

\* In this calculation, right side equation is used  
(Second digit truncation).

$$\text{Compensation value} = \sqrt{(\text{Inverter capacity [kVA]} \times 0.7)^2 - (\text{Motor output [kW]} \div \text{motor efficiency})^2}$$

\* Inverter capacity [kVA] is based on 6.6 kV class in 400-4400 kVA and 11 kV class in over 5000 kVA. In case of applying inverter capacity is nothing, please use a smaller than the capacity.  
Ex) In case of 3.3 kV-1500 kVA inverter, 1200 kV table is used.

### Example

1200 kVA inverter is needed for driving the 1000 kW motor (P.F. = 0.9, Eff. = 95%) as following.

Apparent power :  $1000 \text{ kW} / 0.9 / 0.95 = 1169 \text{ kVA}$

#### (1) Inverter drive one motor by variable frequency and other motors by commercial fixed speed.

In case of 2200 kVA inverter is applied, at most 1540 kVA reactive power can be supplied. ( $2200 \text{ kVA} \times 0.7 = 1540 \text{ kVA}$ )

When 2200 kVA inverter is applied to the above 1000 kW motor, the inverter supply the motor with 1000 kW power and other motors with following reactive power at the same time.

$$\sqrt{1540 \text{ kVA}^2 - (1000 \text{ kW} / 0.95)^2} = 1120 \text{ kVar}$$

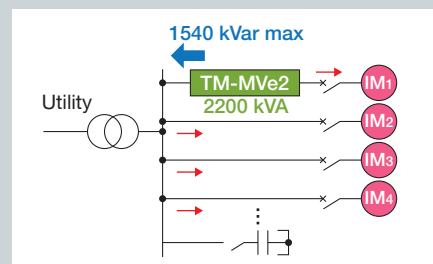

#### (2) Inverter is used for multi synchronous transfer motors and static var compensator

Following reactive power is required from the each synchronous transfer driving motor.

$$1169 \text{ kVA} \times \sqrt{1 - 0.9^2} = 510 \text{ kVar}$$

In this case, if 2200 kVA inverter (1540 kVA reactive power can be supplied) is applied as right side figure, 1530 kVA reactive power (required reactive power for three motors) can be supplied from 2200 kVA inverter.

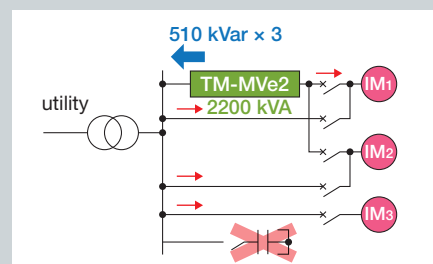

# Product Introduction

## World's smallest class size<sup>\*1</sup>

- The compact design of the TMdrive-MVe2 contributes to significant construction cost reduction. (the enclosure height is 2100 mm for the classes up to 6.6 kV-3000 kVA)<sup>\*2</sup>
- Units up to 6.6 kV-1600 kVA<sup>\*2</sup> can be transported as a single enclosure, simplifying transport, unloading and installation. Installation is safe and straightforward as there are no shipping breaks.
- For export to overseas destinations, the low-height enclosure allows transportation in general-purpose containers, enhancing convenience of transportation. Transportation costs can be reduced.
- The TMdrive-MVe2 is designed for front maintenance, therefore small installation space is required.<sup>\*3</sup>
- Since the input transformer and the inverter enclosure are placed side by side, external cable work is not required.

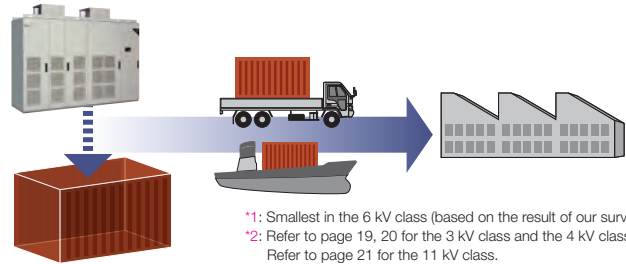

## Reduced load on air conditioning systems

- When there is limited space in the switchroom, the input transformer can be installed externally (optional). The switchroom heating load can be reduced (approx. 50%), which lightens the load to the air conditioning system. Consequentially the running costs of the air conditioning system are reduced.

### Calculation examples

For the 1600 kVA:  
 By using the external transformer, the waste load can be reduced to approx. 32 kW.

## Maintenance cost reduction

- Film capacitors are used for DC smoothing. Maintenance and replacement is not necessary, which significantly reduces the life cycle cost.
- Longer life of the ventilation fan can be achieved. Maintenance costs can be reduced. Conventional models: 3 years → MVe2: 7 years

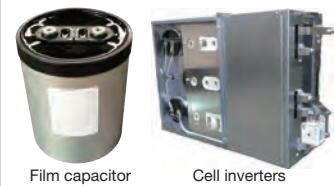
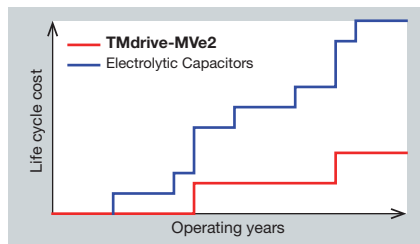

## Application to existing motors

- The multilevel PWM control enables output of voltage in a waveform close to a sine wave. By performing the proprietary switching shift control, an output filter is not required. Motors do not require surge protection. As the heat generated by harmonic currents is suppressed to the minimum, the inverter can be used with existing motors without derating the motor capacity.

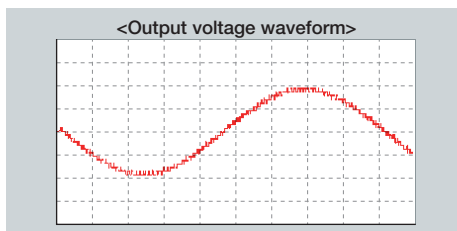

## Easy wiring of control circuit

- Insertion type spring terminals are used for the control circuit. The terminals are highly reliable and facilitate easy wiring. Terminals to suit ring-type crimp lugs are also available (option).

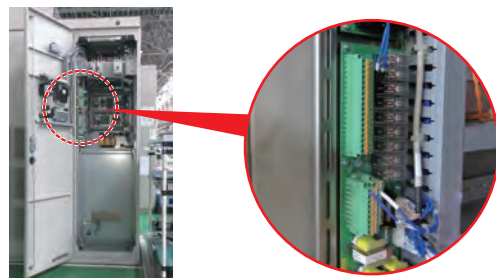

## Improved Productivity

### Suitable rapid acceleration/deceleration operation is available

- The standard power regenerative braking function provides suitable rapid acceleration/deceleration operation with quick speed response.

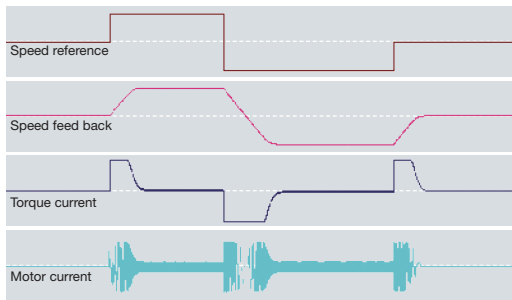

### Stable speed control without speed sensor

- A speed sensor is not required. Thereby, the equipment reliability is improved.
- Sensorless vector control using a theory of vector operations achieves stable speed control.
- For applications requiring a large starting torque, vector control using sensors is also available. (option)
- An auto-tuning function is provided.

### Robust immunity against power supply fluctuation

- The rated voltage output continues even in case of short-time power supply voltage drop or power failure. (Ride-through operation during an instantaneous power failure)

When a power failure occurs, torque output is reduced to zero without tripping, and then returns after the power recovery.

- If a power failure continues for a time longer than the effective time set for the ride-through operation during an instantaneous power failure, the restart function after an instantaneous power failure can be selected.

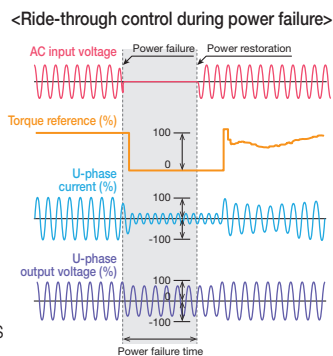

#### Maximum setting time for ride-through operation during an instantaneous power failure and restart after instantaneous power failure

Item	Standard	Optional
Ride-through operation during an instantaneous power failure	0.3 s	3 s (for high inertia motor loads only)
Restart after instantaneous power failure	2 s	6 s (To support automatic restart for power failures longer than 6 seconds, use an external uninterruptible power supply (UPS) unit to supply power.)

### Enhanced applications

- Since the TMdrive-MVe2 output current contains extremely low harmonic content, the influence of torque ripples can be ignored. By suppressing the torsional vibration torque caused by resonance of mechanical systems, stable control is assured, achieving stable operation of machines.

- TMdrive-MVe2 supports constant-torque loads, machines such as extruders or mixers, which

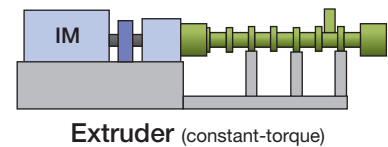

- require large starting torque, and conveyors, reciprocating compressors, and the like, which require regenerative function.

- TMdrive-MVe2 can be used as a motor soft starter. It can be used as a motor soft starter in an application with a large  $GD^2$ , which may have a problem of power supply voltage drop, starting frequency, or the like when the motor is started by commercial power supply. 1 : N common soft starter is supported.
- Synchronous motors can be also controlled (option).

### Short recovery time in case of failures

- By using drawer type cell inverters, the MTTR is as short as 30 minutes (excluding 600 Cell frame).

\* MTTR: Mean Time To Repair



# Product Introduction

## Energy Saving

### Energy saving with speed control

- In variable torque load applications such as fans, pumps or blowers, variable speed operation of inverters achieves significant energy saving effect as compared to the constant speed operation using a commercial power supply (50 Hz or 60 Hz).
- When motor speed control is used in an applications such as a fans, pumps or blowers  
 Air volume (flow)  $\propto$  Speed  
 Required power  $\propto$  (Speed)<sup>3</sup>. For example, when 80% air volume (flow) is required, significant power saving can be achieved by performing the speed control: Required power = (80%)<sup>3</sup>  $\approx$  50%

#### ● Pump application



#### ● Boiler application



#### ● Conveyor application



### Regenerative power feedback to the power supply

- The power regeneration function enables stopping of large inertia loads in a short time. During deceleration, the rotational energy is returned to the power supply, which contributes to a reduction in energy consumption and a reduction in electricity costs.

#### Calculation examples

A machine which decelerates with 1500 kW power in 15 minutes, with a 25% torque  
 → Each time it is stopped, power equivalent to 50 kWh is generated.\*<sup>†</sup>

\* For 6.6 kV-3000 kVA, operating at rated speed and full load

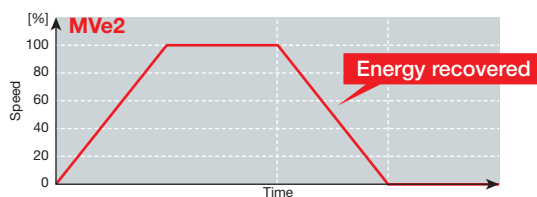

- Regenerative Braking of a conveyor application allows saving of energy during each conveyor stop. Regenerative operation of downhill conveyors allows long term energy savings.

### High efficiency

- The TMdrive-MVe2 has low switching losses of the main circuit elements. Low input side harmonic currents not only result in low losses, but also contributes to improvement of the efficiency of the equipment as a whole by eliminating harmonic filters or power factor improving capacitors.\*

TMdrive-MVe2 variable speed drive system has conversion efficiency of approximately 97%.

\* For 6.6 kV-3000 kVA, operating at rated speed and full load

<TMdrive-MVe2 efficiency curve> (with input transformer)

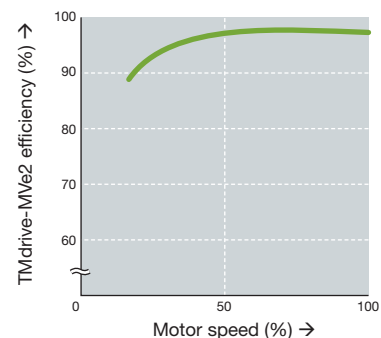

\* Example of the actual load test result of the standard 4-pole motor in our factory



## Power saving with speed control / CO<sub>2</sub> emission reduction

### Power consumption for damper control (at the rated motor speed)

The figure on the right shows a general relationship diagram when the air volume of a fan or a blower is changed from 100% to 70% during the damper control. (H = 1: Rated air pressure, Q = 1: Rated air volume) The necessary shaft power P<sub>1</sub> when Q = 1 is the rated shaft power (kW) of the fan (blower). (= H<sub>0.7</sub>)  
The shaft power P<sub>0.7</sub> required when Q = 0.7 (Q<sub>0.7</sub>) is as follows when the change in efficiency of the fan (blower) is disregarded: P<sub>0.7</sub> = P<sub>1</sub> × Q<sub>0.7</sub> × H<sub>0.7</sub>.  
Consequently, when the motor efficiency is η<sub>M</sub>, the input power P<sub>I1</sub> when Q = 1 and the input power P<sub>I0.7</sub> when Q = 0.7 are as follows:  
P<sub>I1</sub> = P<sub>1</sub>/η<sub>M</sub> (kW), P<sub>I0.7</sub> = P<sub>0.7</sub>/η<sub>M</sub> (kW)  
(However, reduction in the motor efficiency due to reduction in the load rate is disregarded.)

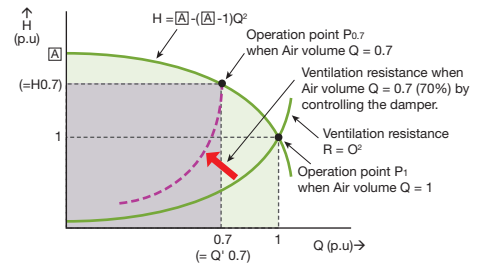

### Power consumption for speed control of inverter

The figure on the right shows a relationship diagram when the air volume regulation of a fan or a blower is changed from 100% to 70% by the speed control of inverter. The input P<sub>I1</sub> required when Q = 1 is the same as that of the damper control. P<sub>I1</sub> = P<sub>1</sub>/η<sub>M</sub> (kW)  
On the other hand, when the 70% air volume = Q<sup>'</sup><sub>0.7</sub>, the operation point is P<sup>'</sup><sub>0.7</sub>. The shaft power P<sup>'</sup><sub>0.7</sub> required in this case is as follows:  
P<sup>'</sup><sub>0.7</sub> = P<sub>1</sub> × Q<sup>'</sup><sub>0.7</sub> × H<sup>'</sup> = P<sub>1</sub> × Q<sup>'</sup><sub>0.7</sub><sup>3</sup>. Consequently, the input P<sup>'</sup><sub>I0.7</sub> required in this case when the inverter efficiency is η<sub>INV</sub> is as follows: P<sup>'</sup><sub>I0.7</sub> = P<sup>'</sup><sub>0.7</sub>/η<sub>INV</sub>  
I<sub>INV</sub> = P<sub>1</sub> × 0.7<sup>3</sup>/η<sub>M</sub>/η<sub>INV</sub>

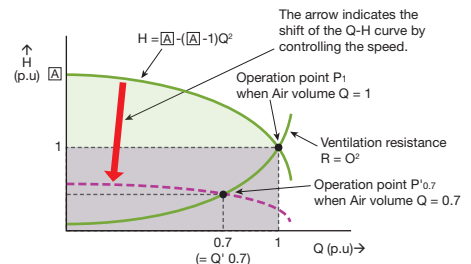

### Calculation examples

Motor efficiency = 96.5%  
TMdrive-MVe2 efficiency = 97%(including transformer)  
Fan shaft power at rated air volume: 1100 kW  
Fan characteristics..... H (when Q = 0) = 1.4 p.u.  
Annual operation time..... 8000 h  
Fan operation pattern.....

- 100% air volume:  
20% of the annual operation time
- 70% air volume:  
50% of the annual operation time
- 50% air volume:  
30% of the annual operation time

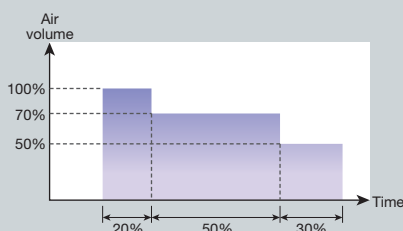

#### ●Damper control

When P<sub>100</sub> = 100% air volume, P<sub>70</sub> = 70% air volume, P<sub>50</sub> = 50% air volume,  
P<sub>100</sub> = 1100/0.965 = 1140 kW  
P<sub>70</sub> = 1100×0.7×(1.4-0.4×0.7×0.7)/0.965 = 961 kW  
P<sub>50</sub> = 1100×0.5×(1.4-0.4×0.5×0.5)/0.965 = 741 kW  
Power consumption = 1140×8000×0.2+961×8000×0.5+741×8000×0.3  
= 7,446,400 kWh/year

#### ●Speed control

When P<sup>'</sup><sub>100</sub> = 100% air volume, P<sup>'</sup><sub>70</sub> = 70% air volume, P<sup>'</sup><sub>50</sub> = 50% air volume,  
P<sup>'</sup><sub>100</sub> = 1100/0.965/0.97 = 1176 kW  
P<sup>'</sup><sub>70</sub> = 1100×0.7<sup>3</sup>/0.965/0.97 = 403 kW  
P<sup>'</sup><sub>50</sub> = 1100×0.5<sup>3</sup>/0.965/0.97 = 147 kW  
Power consumption = 1176×8000×0.2+403×8000×0.5+147×8000×0.3  
= 3,846,400 kWh/year

#### ●Difference between the damper control and the speed control

- ◆Power saving amount: 7,446,400 kWh-3,846,400 kWh = 3,600,000 kWh/year
- ◆Power cost saving: When the electric power unit price is 0.1 dollars/kWh,  
3,600,000 kWh×0.1 (dollars)/kWh = 360,000 dollars /year
- ◆CO<sub>2</sub> reduction: When the CO<sub>2</sub> emission factor is 0.000425 t-CO<sub>2</sub>/kWh\*,  
3,600,000 kWh×0.000425 t-CO<sub>2</sub>/kWh = 1,530 ton

\* An example emission factor of Tokyo Electric Power Company, Inc. from "Emission factors by electric utility in 2007" published by the Ministry of the Environment. In actual calculations, use a factor such as an emission factor default value 0.000555 t-CO<sub>2</sub>/kWh defined in the Ordinance No. 3 of the Ministry of Economy, Trade and Industry and the Ministry of the Environment in 2006, or an emission factor by electric utility company in each year.

# Product Introduction

## Power Supply Friendly

### Input harmonic suppression

- The PWM converter arrangement of the TMdrive-MVe2 meets harmonic regulator's guidelines, without the use of harmonic filters.
- As compared to the diode converter, the new model reduces harmonics in the lower order numbers, such as fifth or seventh.

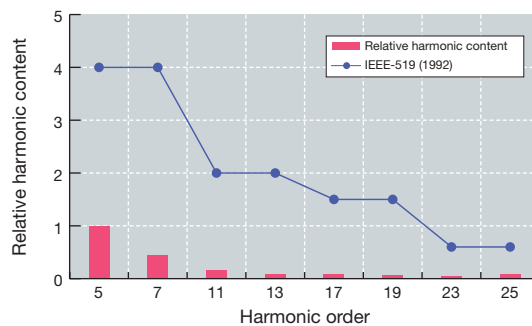
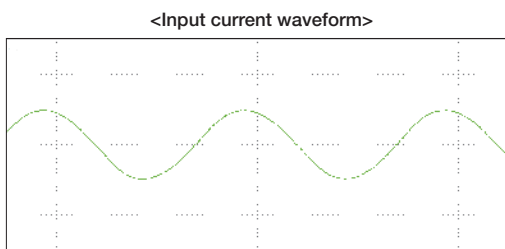

- **TMdrive-MVe2 relative harmonic content on the input side** (measurements in the actual load test of the 1600 kVA)

Order	5th	7th	11th	13th	17th	19th	23th	25th
Relative harmonic content (%)	1.0	0.45	0.16	0.08	0.08	0.06	0.04	0.08
IEEE-519 (1992) (%)	4.0	4.0	2.0	2.0	1.5	1.5	0.6	0.6

### High input power factor

- The PWM converter enables operations with a power factor 1. The basic contract charge with the electric power supplier can be reduced.  
 Basic charge = Unit price × Contract power × (185-Power factor)/100  
 As a result of the input power factor change from 95% (diode converter) to 100% (PWM converter), the basic charge is reduced by 5%.
- The PWM converter generates leading or lagging reactive power within the inverter's capacity range independently of the motor operation by the inverter. By using the PWM converter, the equipment required for the power factor improvement of the system can be reduced. Furthermore, continuous control is enabled, ensuring stability of the input power factor even when the load fluctuates.

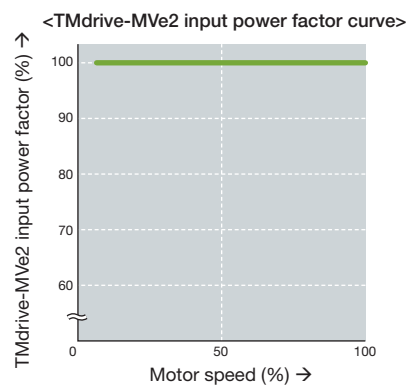

\* Example of the actual load test result of the standard 4-pole motor in our factory

### Excitation inrush current reduction

- The reactor initial charging method is applied for 300 Cell Frame or higher to limit the excitation inrush current for the input transformer and reduce the voltage drop in the system.

Note) For installing the input transformer separately, contact your sales representative.

Rated voltage	Cell Frame size				
	100	200	300	400	600
3.3/3.0 kV	Direct pre-charge system				ACL pre-charge system
4.16 kV					
6.6/6.0 kV					
10/11 kV					

## Simple Commissioning, Operation and Troubleshooting



An LC display is used on the operation panel.  
The inverter operating condition can be monitored on the easy-to-view display screen.  
Parameter setting and troubleshooting can be also performed easily.

### ● LC graphic display

- <240X64 dots, monochrome>
- Operating status display (characters/graphs)
- Fault information display (characters)
- Parameter display

### ● Operation status indicator (LED)

### ● Ethernet connector

### Operation panel



### <Main functions>

- Parameter input/change
- Display mode switching
- Local/remote switching

### ● Discharge check LED

### ● Fault reset switch

### ● Interlock switch

<with protective cover>

### ● Analog output check pins

- Current feedback output: 2 channels
- Analog output for measurement/monitoring: 5 channels

### Easy device setting/checking (option)

- A high-performance display is available. It is compatible with nine languages, and has a touch panel. Anyone can check the system condition on the control panel. A variety of settings can be easily performed on the display.



Language	
Japanese	English
Chinese	Russian
Spanish	Portuguese
French	Italian
Korean	

### Drive Troubleshooting

- This screen displays a drive first fault and shows selected trend displays to assist in determining the cause. The fastest trend displays four variables sampled at a rate of 333 microseconds. The other two slower trends are sampled at 1 millisecond and 100 milliseconds.

#### Available Troubleshooting Functions

- First fault display
- Operation preparation display
- Fault trace back
- Trouble records
- Fault history display
- Online manual

### Support function via network connection (option)

- Central control of multiple devices is available in the server.
- Trace data of faults can be checked in the control room. It is not necessary to go over to the control panel. The system condition can be checked from a remote place.
- By using a maintenance tool function (option), the system condition can be checked via the Internet. Adjustment and maintenance are facilitated.

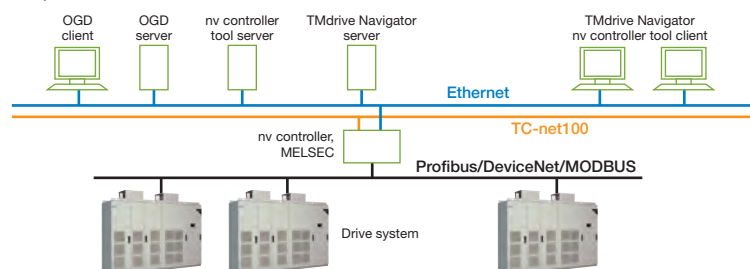

# Circuit Configuration

## Main circuit configuration diagram

The TMdrive-MVe2 consists of a dedicated input transformer and a single phase IGBT inverters (cell inverters).

Six cell inverters are connected to 3 kV/4 kV class, nine inverters to 6 kV class, and fifteen inverters to 11 kV class, which allows three-phase high voltage AC output of 3 kV, 4 kV, 6 kV, and 11 kV respectively.

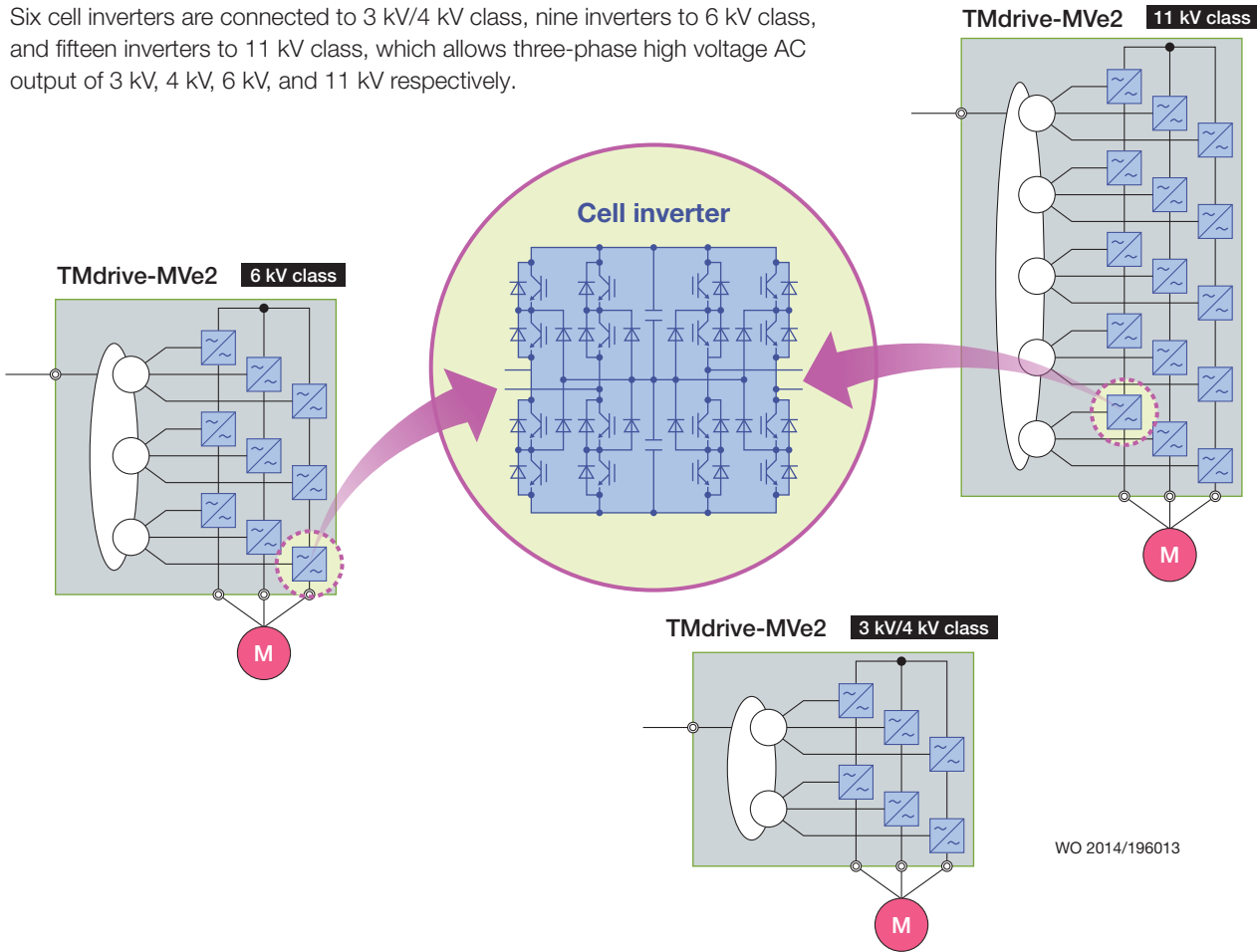

## System configuration

### (1) Inverter individual operation

The inverter operates alone.



### (2) Electronic bypass operation

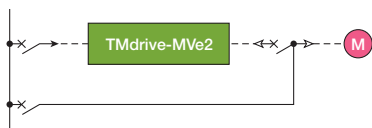

Operation using a commercial power supply is also available. It is suitable for applications in which, for example, a motor is driven at a rated speed for a certain period of time, or a duplex power supply is used for a motor.

## Control block diagram

The sensorless vector control offers strong and smooth operations.

Installing 32 bit microcomputer (PP7EX2) specially designed for power electronics in MPU allows a highly reliable operation.

(The vector control with sensor is also available depending on requirements for a high quality speed control or a larger starting torque. An open loop type V/f control is also available.)

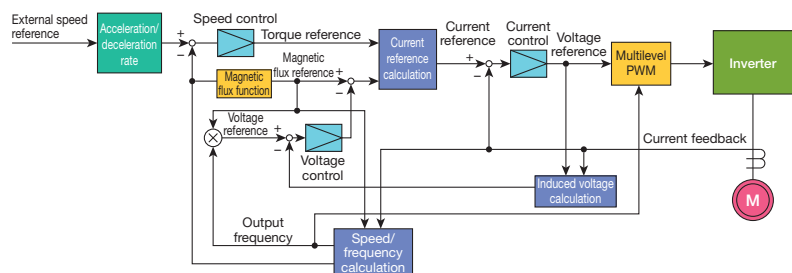

## Standard connection diagram

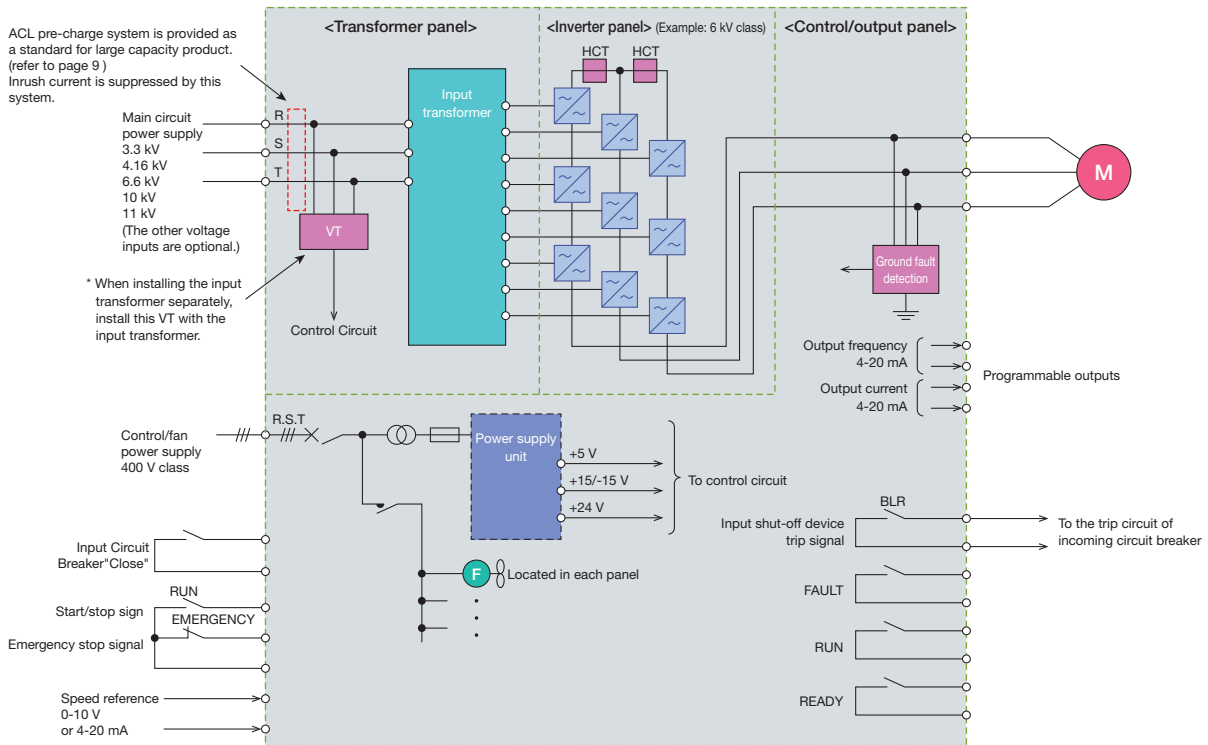

## Standard interface

### Customer → Inverter

Main circuit power supply	Main circuit power supply	
Control/fan power supply*	Control/fan power supply	380 to 440 V (50 Hz) / 400 to 440 V (60 Hz) / Other options
Start/stop signal	"Closed" to operate, "opened" to stop	Dry contact: 24 VDC-12 mA
Emergency stop signal	"Closed" during normal operation, "opened" to initiate an emergency stop (coast-to-stop)	Dry contact: 24 VDC-12 mA
Incoming contactor status signal (or CBS)	"Closed" when the circuit breaker is closed	Dry contact: 24 VDC-12 mA
Output circuit breaker status signal (or CBS)	"Closed" when the circuit breaker is closed	Dry contact: 24 VDC-12 mA (if an output contactor is installed)
Speed reference signal	0-10 V = 0-100% or 4-20 mA = 0-100%	Input impedance 8 kΩ (0-10 V)
		Input impedance 500 Ω (4-20 mA)

\* Separate step-down transformer for the control power supply (from 400 V to 200 V) (option)

### Inverter → Customer

Operation ready signal	"Closed" when the inverter is ready for operation	Dry contact (maximum 220 VAC-0.8 A, 110 VDC-0.2 A, 24 VDC-1.5 A)
Running signal	"Closed" when the inverter is running	Dry contact (maximum 220 VAC-0.8 A, 110 VDC-0.2 A, 24 VDC-1.5 A)
Fault signal	"Closed" when an inverter fault occurs	Dry contact (maximum 220 VAC-0.8 A, 110 VDC-0.2 A, 24 VDC-1.5 A)
Incoming circuit breaker trip signal	"Closed" when an inverter fault occurs (for tripping incoming circuit breaker)	Dry contact (maximum 220 VAC-0.8 A, 110 VDC-0.2 A, 24 VDC-1.5 A)
Output current	4-20 mA = 0-125% current	Resistive load 500 Ω or lower
Motor speed	4-20 mA = 0 to 125% speed	Resistive load 500 Ω or lower

# Standard Specifications

## Standard rating

Item																
3.3/3.0 kV	At 3.3 kV output [kVA]	200	300	400	600	800	950	1100	1300	1500	2090	2850				
	Rated Current [A]	35	53	70	105	140	166	192	227	263	364	499				
	Overload Current [A]	38	58	77	115	154	182	211	249	289	400	548				
	Application motor output [kW]*1	160	250	320	450	650	750	900	1000	1250	1600	2250				
	Cell Frame	100			200			300		400		2x300*2		2x400*2		
4.16 kV	At 4.16 kV output [kVA]	500	1000	1380	1890	2770	3590	5260								
	Rated Current [A]	69	139	192	262	384	499	730								
	Overload Current [A]	75	152	211	288	422	548	642								
	Application motor output [kW]*1	400	810	1120	1600	2250	2800	4045								
	Cell Frame	100	200	300	400	600	2x400*2	2x600*2								
6.6/6.0 kV	At 6.6 kV output [kVA]	400	600	800	1000	1200	1400	1600	1900	2200	2600	3000	3600	4400	5700	8360
	Rated Current [A]	35	53	70	87	105	122	140	166	192	227	263	315	385	499	731
	Overload Current [A]	38	58	77	95	115	134	154	182	211	249	289	346	423	548	643
	Application motor output [kW]*1	315	450	650	810	1000	1130	1250	1600	1800	2250	2500	2800	3550	3960	7100
	Cell Frame	100			200				300			400		600		2x400*2
10/11 kV	At 11 kV output [kVA]	660	990	1320	2000	2640	3080	3630	4290	5000	6000	7350				
	Rated Current [A]	35	53	70	105	139	162	191	226	263	315	385				
	Overload Current [A]	38	58	77	115	152	178	210	248	289	346	423				
	Application motor output [kW]*1	500	800	1000	1600	2040	2500	2800	3500	3860	4900	5800				
	Cell Frame	100			200			300		400		600				

\*1 Approximate value for the standard 4-pole motor.

\*2 Please contact us for the outline of 2 bank products.

## Energy Saving Medium Voltage Inverter Family

**Voltage/capacity range**

**MVG2** 200 kVA to 19500 kVA

**MVe2** 200 kVA to 8360 kVA

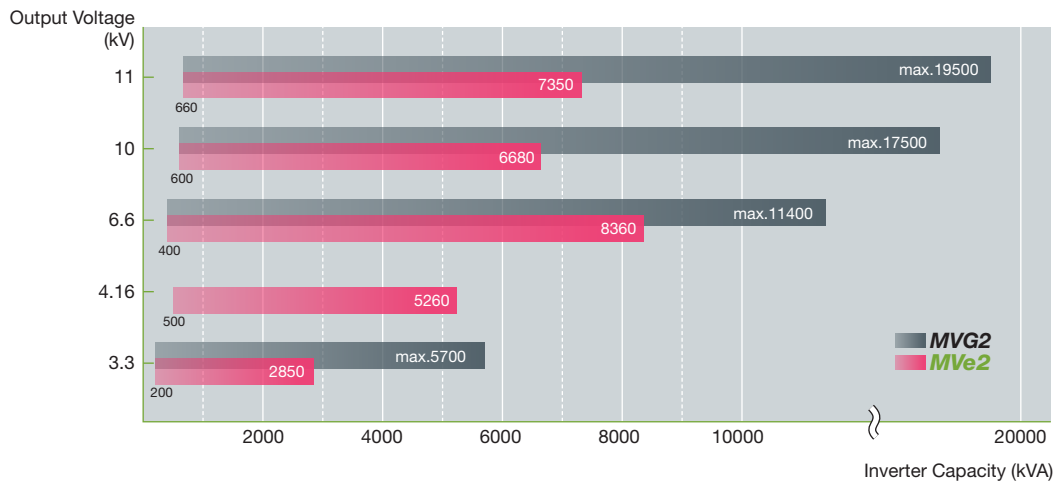

## Standard specifications list

Item		
Output	Output frequency (Hz)	Rated output frequency of 50 or 60 Hz Option: up to 120 Hz (3 kV/4 kV/6 kV) / 72 Hz (10 kV/11 kV)
	Overload capacity	110 % - 60 seconds
Input	Main circuit	Three phase 3000, 3300, 4160, 6000, 6600, 10000, 11000 V - 50/60 Hz
	Control/fan circuit	380 to 440 V (50 Hz) / 400 to 440 V (60 Hz) / Other options
	Permissible fluctuation	Voltage: $\pm 10\%$
Input power factor/ regenerative capacity		Fundamental wave power factor of approximately $\text{pf}=1.0$ , Max regenerative capacity of 80%
Control function	Control method	Sensorless vector control, vector control with sensor, or V/f control + Multilevel PWM (Pulse Width Modulation)
	Frequency accuracy	$\pm 0.5\%$ for maximum output frequency (for the analog frequency reference input)
	Load torque characteristic	Variable torque load, constant-torque load
	Acceleration/deceleration time	0.1 to 3600 seconds, individual setting possible (Setting depends on the load $\text{GD}^2$ )
	Primary control functions	Soft stall (Programmable speed reduction for fans and pumps during periods of overload), Ride-through control during instantaneous power failures, break point acceleration/deceleration function, specific frequency evasion function, continuous operation function during speed reference loss, total run time display function
	Primary protective functions	Refer to page 15 to 17.
	Transmission (option)	DeviceNet, Profibus-DP, Modbus-RTU, TC-net I/O, CC-Link
Display function	Display	LCD display (240x64 dots) 4 LED indicators (READY, RUN, ALARM/FAULT, Discharge check)
	Push buttons	NAVIGATION key, CONTROL key, Operation, stop, fault reset, interlock (drive run inhibit)
Input transformer		Class H, dry type, TMdrive-MVe2 dedicated specifications (External options and external oil type trans. options available)
Structure	Enclosure	IP30 (except for the cooling fan opening) Option: IP42 (except for the cooling fan opening)
	Enclosure structure	Steel-plate, semi-closed, self-supporting enclosure structure for a front maintenance. The 3.3 kV and 4.16 kV models without optional features and the 11 kV model require maintenance from front and rear.
	Cooling system	Forced air cooling by a ceiling fan
	Finish color	Munsell 5Y7/1, leather-tone finish
Ambient condition	Ambient temperature	0 to 40°C (Higher temperature with derating)
	Humidity	85% or less (no dew condensation)
	Altitude	Up to 1000 m (Higher with derating)
	Vibration	0.5 G or less (10 to 50 Hz)
	Installation location	Indoor (free from corrosive gas, dust and dirt)
Load pattern		Fans, blowers, pumps, compressors, extruders, fan pumps, mixers, conveyors, etc.
Applicable standards		Electrical standards: JEC, IEC Component and others: JIS, JEC, JEM

# Standard Specifications

## Typical protective functions

Item	Abbreviation	Content
Cell converter over current	xn_C_OCA* <sup>1</sup>	The AC over current detection circuit (hardware) of the x-phase n <sup>th</sup> cell converter activated.
Cell over voltage P side	xn_OVP* <sup>1</sup>	The P side over voltage detection of the x-phase n <sup>th</sup> cell activated.
Cell over voltage N side	xn_OVN* <sup>1</sup>	The N side over voltage detection of the x-phase n <sup>th</sup> cell activated.
Cell over heat	xn_OH* <sup>1</sup>	An overheat condition of the x-phase n <sup>th</sup> cell is detected.
Cell gate power supply failure	xn_GPSF* <sup>1</sup>	The gate power supply failure detection circuit (hardware) of the x-phase n <sup>th</sup> cell activated.
Cell failure	xn_CELL_F* <sup>1</sup>	An x-phase n <sup>th</sup> cell failure has occurred.
AC overcurrent	OCA	The AC over current detection circuit (hardware) activated. (In 2 bank product, this function is activated for A bank.)
Over current AC B bank	OCA_B	The AC over current detection circuit (hardware) in the B bank activated. (This function is used only in 2 bank system.)
Master CPU failure	CPU_M	The watchdog failure has occurred in the main CPU of the CTR board.
Slave CPU A failure	CPU_A	The watchdog failure has occurred in the slave CPU-A of the CTR board.
Inverter output voltage PLL error	VPLL_ERR	Excessive phase error of the IPLL has been detected.
Over voltage (soft detection)	OV_S	The drive has detected, that an inverter output voltage is greater than the over voltage protection level MS_CP_OV.
Current failure of U/W-phase	CURU CURW	The U/W-phase current could not be detected. (In 2 bank product, this function is activated for A bank.)
Current failure of U/W-phase B bank	CURU_B CURW_B	The U/W-phase current could not be detected. (This function is used only in 2 bank system.)
Overspeed	OSS	An overspeed of the motor has been detected.
Output frequency exceeded	OSS_FO	Excessive output frequency has been detected.
Speed detection error	SP_ERR	A speed feedback error has been detected.
Zero speed starting interlock	SP_SIL	Because the motor is running, a startup interlock condition cannot be made.
Speed reference lost	SP_LOST	SP_LOST detects the speed reference lost. (1) SP_LOST turns off the UV signal (Electrical condition) and performs a free-run stop (coast to stop). (2) SP_LOST turns off the HFD signal (Heavy fault) and performs a free-run stop (coast to stop). (3) SP_LOST turns off the READY signal and performs a slowdown stop (deceleration to stop).
Speed reference lost alarm	SP_LST_A	Detects the speed reference lost.

\*1 The character "x" shows U, V, W-phase, and the "n" shows cell's number of columns 1-6.



Item	Abbreviation	Content
Motor rotate failure	ROT_F	The motor stall has been detected.
Reverse rotate failure	REV_ROT_F	REV_ROT_F detected the motor was rotating in the opposite direction to the speed reference.
Control power source failure	CPSF	The control power supply voltage has dropped.
Main power source failure	MPSF	An AC main power supply loss has been detected during operation.
+15V or -15V of voltage error	PN15_F	A voltage error of +15V or -15V has been detected.
Rectifier failure	REC_F	REC_F detected that the drive doesn't establish the DC voltage when the main AC input is on.
Uninterruptible power supply unit error	UPS_ERR	The control power supply failure detected, in an optional system, that the uninterruptible power supply unit (UPS), supplying the control power, failed.
AC input circuit breaker open	AC_P_T	The input AC circuit breaker (AC_MCCB) is open.
Electrical condition	UV_MPSF	An AC main power supply loss has been detected during operation.
AC main voltage drop	UVA_SIL	An AC main power supply loss has been detected.
Overload (5 minutes) RMS	OL5	The RMS AC current has exceeded the set value for 5 minutes.
Overload (20 minutes) RMS	OL20	The RMS output current has exceeded the set value for 20 minutes.
Equipment overload alarm	OL_A	The RMS AC current has exceeded the set value for 5 minutes.
Current limit timer	CL_T	The detection of operation above a current limit has continued for the time set with the timer.
Current limit timer alarm	CL_TA	The detection of operation above a current limit has continued for the 80% of time set with the timer.
Converter overload (5 minutes) RMS	OL5_B	The RMS converter current has exceeded the set value for 5 minutes.
Converter overload (20 minutes) RMS	OL20_B	The RMS converter current has exceeded the set value for 20 minutes.
Converter overload alarm	OL_A_B	The RMS converter current has exceeded the set value for 5 minutes or 20 minutes.
Converter Current limit timer	CL_T_B	The detection of operation above a current limit has continued for the time set with the timer.
Converter current limit timer alarm	CL_TA_B	The detection of operation above a current limit has continued for the 80% of time set with the timer.
Automatic speed reduce operating in overload	SOFT_STL	The operation is in soft stall mode due to an overload or high temperature.
Equipment ventilating fan stopped timer	C_FN_T	Abnormal status of the equipment ventilating fan continued for the length of time set with the timer TIME_CFAN.
Equipment ventilating fan stopped	C_FN	An equipment ventilating fan error has been detected.

# Standard Specifications

## Typical protective functions

Item	Abbreviation	Content
Equipment ventilating redundancy fan stopped timer	C_FN_B	A redundant equipment ventilating fan error has been detected.
Ground detection timer	GR_T	A ground fault has been detected.
Ground detection alarm	GR_A	GR_A detects when the ground current increases above the ground detection alarm level.
DC voltage drop	UVD	A Power supply voltage drop was detected in the DC main circuit while the drive was running.
DC voltage drop starting interlock	UV_SIL	The DC voltage is equal to or less than setting value and the drive is not allowed to start.
System configuration error	SYS_ERR	A system configuration setting error has been detected. The drive turns off the UVA signal.
Set parameter check error	PARA_ERR	This is a checksum error of parameter setting value.
External interlock	IL	An external interlock signal has been lost.
External equipment electrical condition ready condition	UVA_EX	UVA_EX is an external electrical condition signal.
External safety switch	UVS	The "operation interlock switch input", from outside the master cubicle, is off.
Panel interlock switch on	P_SW	The interlock switch on the cubicle is in "Operation prohibited" (lamp lit) status.
AC contactor fault	ACSW_F	The contactor on the load side was open during operation.
AC contactor opened timer	ACSW_T	The contactor on the load side is open.
AC contactor closed	ACSW_C	The contactor on the load side is closed although it is not turned on.
Output side open	NO_LOAD	An open load has been detected. The drive turns off the UVA signal and stops. The NO_LOAD signal is generated when the feedback current becomes one eighth or less of the excitation current.
Overheat transformer	OH_TR	An overheat condition of the transformer has occurred.
Input transformer high temperature alarm	OH_TR_A	The overheat alarm of the input transformer panel tripped.
ACL overheat timer	OH_ACL_T	The ACL overheat condition continued for the length of time set with the TIME_ACL timer.
ACL overheat	OH_ACL	An ACL overheat has been detected.
General analog input signal lost fault	AIN_FAULT	Current signal fell lower than 4mA when using the 4-20mA current type general analog input.
Input voltage phase loss detection	VAC_PH_LOSS	Input AC voltage phase loss has been detected.
Output Current phase loss detection	VINV_PH_LOSS	An Output AC current phase loss has been detected.
Input voltage phase rotate failure	VAC_ROT_F	Incorrect input AC voltage phase rotation has been detected.
Voltage Feedback failure	VFBK_F	A failure of the output Voltage of the inverter has detected.
Voltage feedback failure alarm	VFBK_F_A	A failure of the output Voltage of the inverter has detected.
Pre-charge contactor failure	PRE_CTT_F	An error was detected in the contactor of the pre-charge circuit.
Pre-charge contactor opened	PRE_CTT	The contactor of the pre-charge circuit is open. When the UVS signal is off or there is no DC power, the contactor of the pre-charge circuit would not be closed.



## Option

Output frequency	Maximum output frequency for 3 kV/4 kV/6 kV: 120 Hz, for 10 kV/11 kV: 72 Hz
Control method	Vector control with sensor (encoder or resolver)
	Static Var Compensation (Refer to page 3,4), Restart after instantaneous power failure (Refer to page 6), synchronous transfer to and from commercial power supply (shock-less switching over between power supplies), soft start
Maintenance tools	Personal computer application software for maintenance and adjustment (OS: Windows®7 Professional 32-bit version)
Others	Multi-language display on the operation panel (supports eight languages other than Japanese), SM control, redundant cooling fans
	Specified painting color
	Outlet, in-enclosure lightings, space heater, separate input transformer, inrush current suppression circuit (small-capacity model), different input voltage, emergency stop button, IP42 enclosure (except for the cooling fan opening)

\* For installing the transformer separately or using the inrush current suppression circuit, contact your sales representative for the enclosure size.  
For the 3 kV class and the 4 kV class, if it is required to store a step-down transformer for control power supply, redundant cooling fans, top cable entry, have outlets, in-enclosure lightings, and space heaters, or install the transformer separately, contact your sales representative.

## Inverter selection guide

### Items to be informed

\* Please designate the following items on your inquiry.

- (1) Application (equipment name)
- (2) Load type (fan, blower, pump, compressor, etc.)
- (3) Torque characteristics (square variable-torque, constant-torque, with constant output range, etc.)
  - GD<sup>2</sup> of the load:  (kgm<sup>2</sup>) (Motor axis conversion)
  - Required overload capacity  % -  second
  - Speed-torque curve of the load:
  - Necessary starting torque:  %
- (4) Driving motor
  - New or existing
  - Power output:  (kW)
  - Number of poles:  (P)
  - Voltage:  (V)
  - Speed:  (min<sup>-1</sup>)
  - Rated frequency:  (Hz)
  - Rated current:  (A)
- (5) Main circuit input voltage/frequency:  (V) -  (Hz)
- (6) Control/fan power supply voltage/frequency: Three-phase three-line  (V) -  (Hz)
- (7) Range of operating frequency:  Hz to  Hz
- (8) Operating frequency setting (automatic signal <4 to 20 mA>, manual setting on the operation panel, speed increase/decrease signal, etc.)
- (9) Commercial bypass operation (with/without)
- (10) Installation condition
  - Ambient temperature:  to  °C
  - Humidity:  % (no dew condensation)
  - Air conditioning systems: (with/without)
  - Space limitation for transportation on site:

### Inverter capacity calculation

If the rated current of the motor that the inverter is going to drive is I (A), and the related voltage V (kV), the necessary capacity of the inverter (kVA) is calculated by Inverter capacity (kVA) =  $\sqrt{3} \times V \times I \dots (1)$ .

The capacity of inverter must be larger than the capacity calculated from (1).

Additionally, the inverter capacity on the standard specifications list is printed at 3.3 or 6.6 kV output. For the inverter capacity at 3 or 6 kV output, it requires multiplying 0.9.

# Outline Dimensions (Unit: mm)

## 3 kV / 4 kV class

### Outline dimensions (standard specifications)

- 3.3 kV-200/300/400 kVA
- 4.16 kV-500 kVA

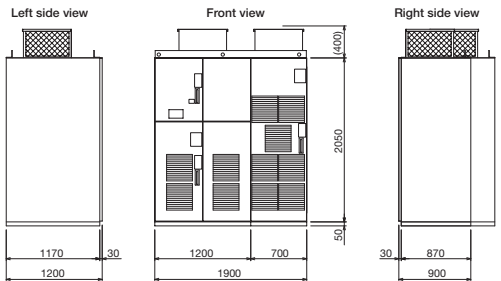

Approx. mass: 3800 kg

- 3.3 kV-600/800 kVA
- 4.16 kV-1000 kVA

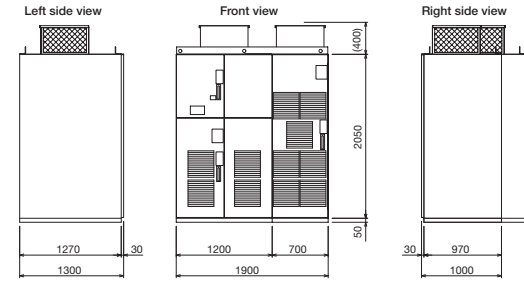

Approx. mass: 4000 kg

- 3.3 kV-950/1100 kVA
- 4.16 kV-1380 kVA

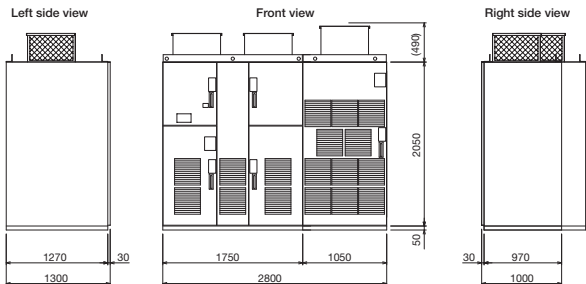

Approx. mass: 5300 kg

- 3.3 kV-1300/1500 kVA
- 4.16 kV-1890 kVA

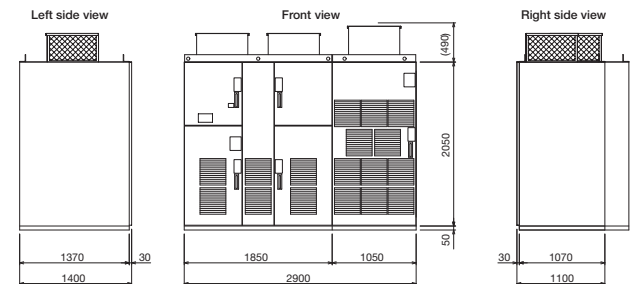

Approx. mass: 5600 kg

### Reference outline dimensions with an optional enclosure

For the 3 kV and 4 kV class models refer to the outline dimensions shown below.

- 3.3 kV-200/300/400 kVA
- 4.16 kV-500 kVA

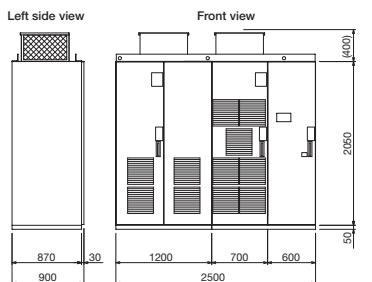

Approx. mass: 3800 kg

- 3.3 kV-600/800 kVA
- 4.16 kV-1000 kVA

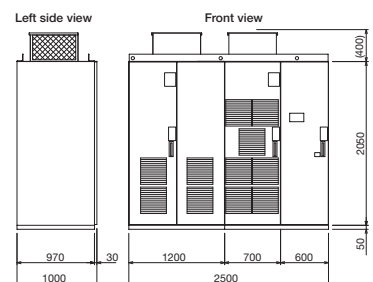

Approx. mass: 4000 kg

- 3.3 kV-950/1100 kVA
- 4.16 kV-1380 kVA

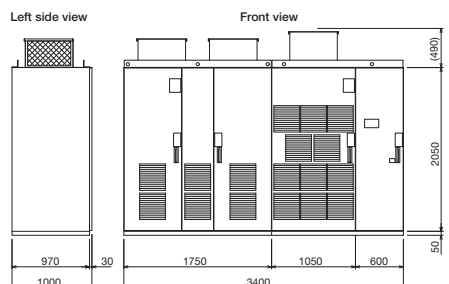

Approx. mass: 5300 kg

- 3.3 kV-1300/1500 kVA
- 4.16 kV-1890 kVA

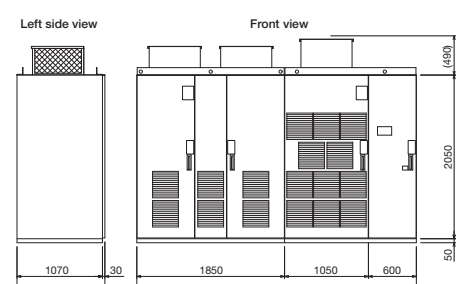

Approx. mass: 5600 kg

\* The above reference outline dimensions assume the same enclosure configuration for the input transformer, inverter, and control/output panel as that of MVG2.

# TMdrive -MVe2 series

## Outline dimensions for North-America model (4 kV class)

### • 4.16 kV-500/1000 kVA

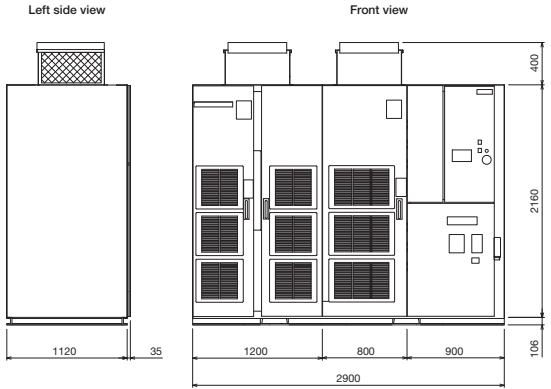

Approx. mass: <500 kVA> 2800 kg  
<1000 kVA> 3440 kg

### • 4.16 kV-1380/1890 kVA

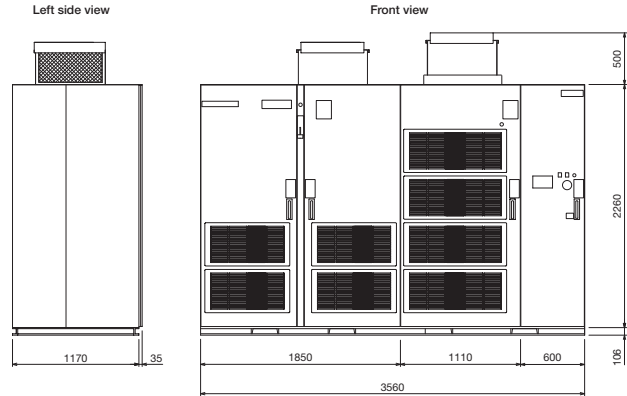

Approx. mass: <1380 kVA> 4450 kg  
<1890 kVA> 5000 kg

### • 4.16 kV-2770 kVA

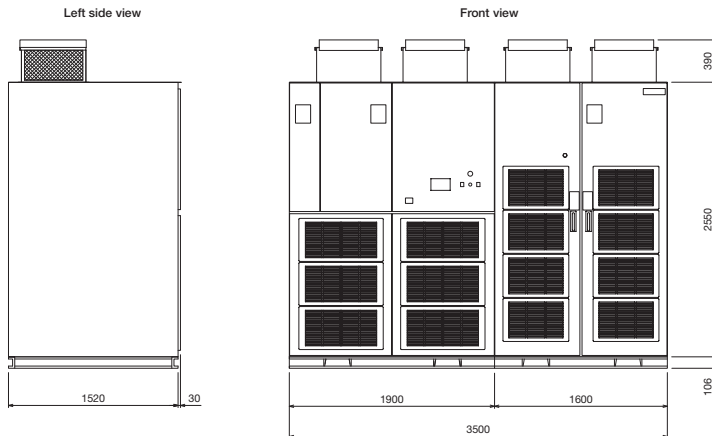

Approx. mass: 8600 kg

Outline Dimensions

## Maintenance space

Output voltage (kV)	Inverter capacity (kVA)	Front maintenance space (mm)	Rear space (mm)	Upper space (mm)
3.3	200 to 800	1700	600	300
	950 to 1500	1700	600	210
4.16	500 to 1000	1700	600	300
	1380 to 1890	1700	600	210
4.16 North-America model	2770	1900	600	210
	500 to 1000	1700	600	300
North-America model	1380 to 1890	1700	600	200
	2770	1700	600	310

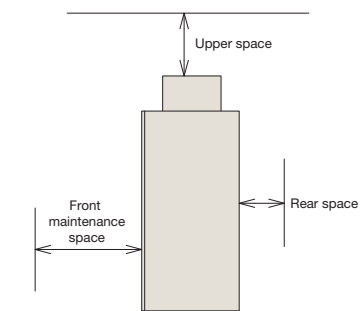

Please contact us about other capacity outline and maintenance space.

# Outline Dimensions (Unit: mm)

## 6 kV class

### Outline dimensions (standard specifications)

#### • 6.6 kV-400/600/800 kVA

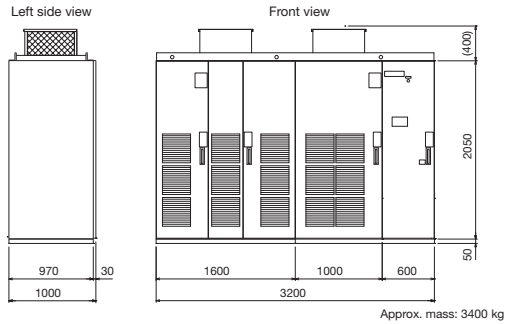

#### • 6.6 kV-1000/1200/1400/1600 kVA

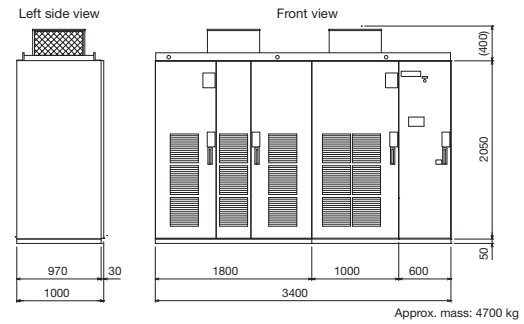

#### • 6.6 kV-1900/2200/2600/3000 kVA

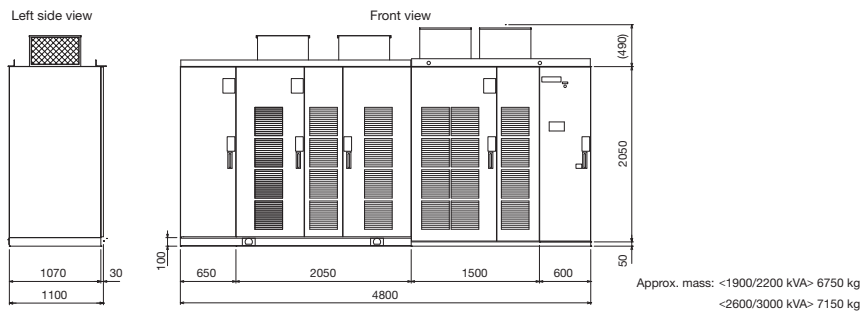

#### • 6.6 kV-3600/4400 kVA

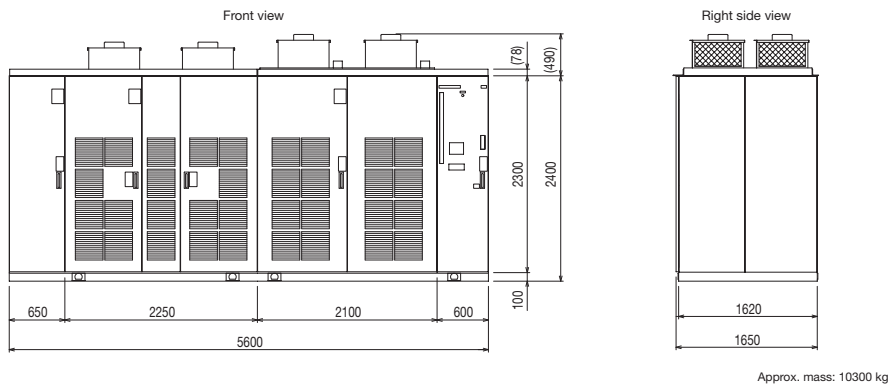

### Maintenance space

Output voltage (kV)	Inverter capacity (kVA)	Front maintenance space (mm)	Rear space (mm)*	Upper space (mm)
6.6	400 to 1600	1700	20	300
	1900 to 3000	1700	20	210
	3600 to 4400	1900	20	210

\* For bolting the VFD to the wall (Wall Strength is needed)

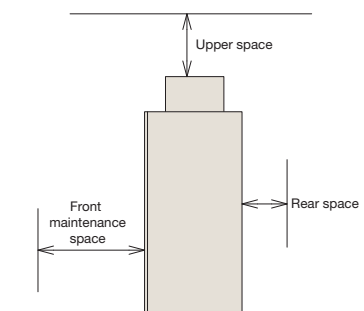

Please contact us about other capacity outline and maintenance space.

# TMdrive -MVe2 series

## 11 kV class

### Outline dimensions (standard specifications)

#### • 11 kV-660/990/1320/2000/2640 kVA

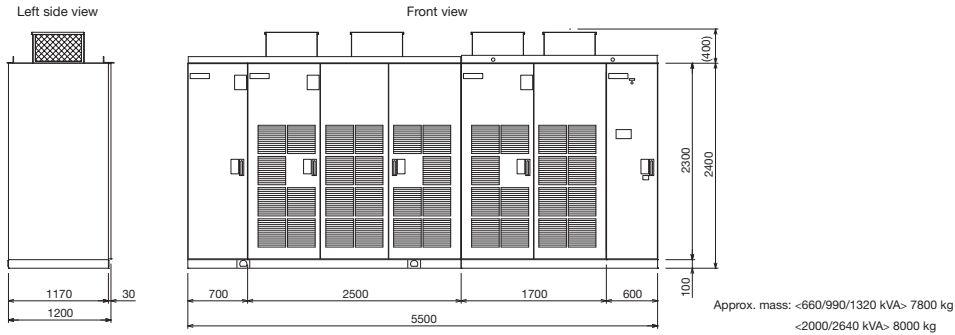

#### • 11 kV-3080/3630/4290/5000 kVA

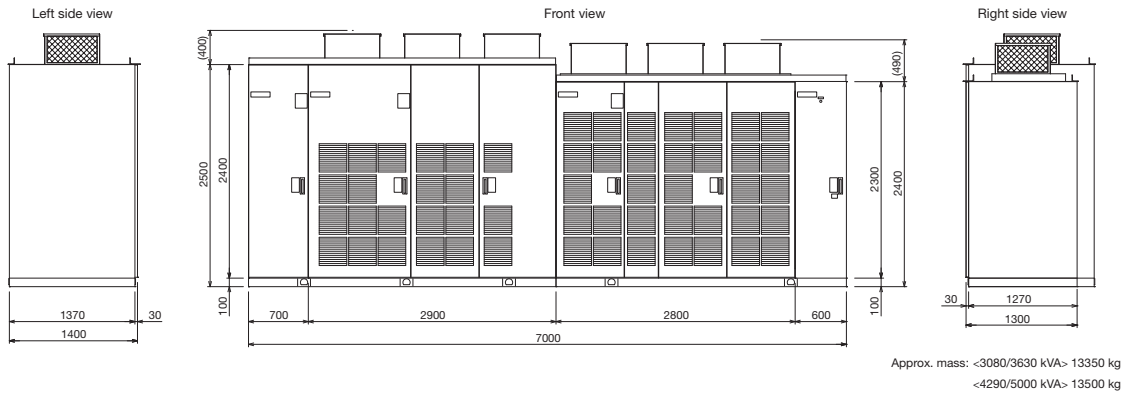

#### • 11 kV-6000/7350 kVA

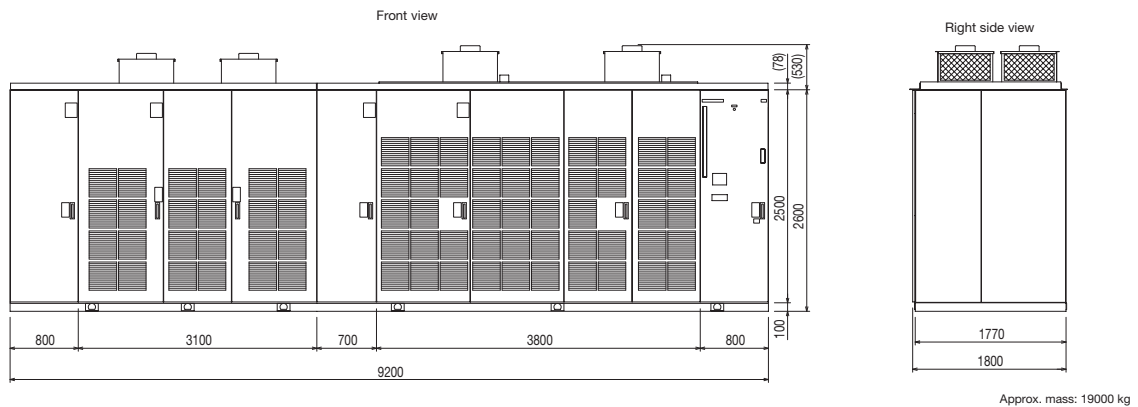

### Maintenance space

Output voltage (kV)	Inverter capacity (kVA)	Front maintenance space (mm)	Rear space (mm)	Upper space (mm)
11	660 to 2640	1900	600	300
	3080 to 7350	1900	600	210

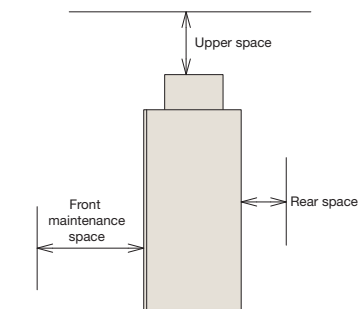

Please contact us about other capacity outline and maintenance space.



## Global Office Locations :

### Toshiba Mitsubishi-Electric Industrial Systems Corporation

TOKYO SQUARE GARDEN, 3-1-1 Kyobashi, Chuo-ku,

Tokyo 104-0031, Japan

Phone: +81-3-3277-4510 Fax: +81-3-3277-4566

Web: [www.tmeic.co.jp/global/index.html](http://www.tmeic.co.jp/global/index.html)

### Overseas Affiliates

#### North America

##### TMEIC Corporation

Office Location: 1325 Electric Road, Roanoke VA 24018 U.S.A.

Mailing/Receiving Address: 2060 Cook Drive, Salem,

Virginia 24153 U.S.A.

Phone: +1-540-283-2000 Fax: +1-540-283-2001

Web: [www.tmeic.com/](http://www.tmeic.com/)

##### Houston Branch Office

2901 Wilcrest Drive, Suite 110, Houston, TX 77042, U.S.A.

Phone: +1-713-784-2163 Fax: +1-713-784-2842

#### South America

##### TMEIC SISTEMAS INDUSTRIAIS DA AMERICA DO SUL LTDA

Av. Paulista 1439, Sala 72, Bela Vista 01311-200 Sao Paulo SP

Phone: +55-11-3266-6161 Fax: +55-11-3253-0697

#### EUROPE

##### TMEIC Europe Limited

6-9 The Square, Stockley Park, Uxbridge, Middlesex, UB11 1FW, U.K.

Phone: +44-870-950-7220 Fax: +44-870-950-7221

##### Italy Branch Office

Via Pappacena, 22 70124 Bari

Phone: +39-080-5046190 Fax: +39-080-5042876

#### ASIA

##### Toshiba Mitsubishi-Electric Industrial Systems (CHINA) Corp.

B-21F Indo Mansion, 48A Zhichunlu, Haidian Dist.

Beijing 100098, PRC

Phone: +86-10-58732277 Fax: +86-10-58732208

##### Shanghai Branch Office

2603-2608 Shanghaimart, 2299 Yan'An Rd(W), Changning District,

Shanghai 200336 PRC

Phone: +86-21-62360588-502 Fax: +86-21-64413019,62360599

##### Shanghai Bao-ling Electric Control Equipment Co., Ltd.

7/F NO.1 Building, Lane1588, You Yi Road, Baoshan District,

Shanghai 201998

Phone: +86-21-3621-3659 Fax: +86-21-3621-2668

##### Guangzhou Toshiba Baiyun Ryoki Power Electronics Co., Ltd.

The No.18 Daling Nan Lu, Jiangao Town Shen Shan, Baiyun

District, Guangzhou

Phone: +86-20-2626-1625 Fax: +86-20-2626-1290

##### TMEIC Asia Pte. Ltd.

152 Beach Road, #13-07/08 Gateway East, 189721 Singapore

Phone: +65-6292-7226 Fax: +65-6292-0817

##### Taiwan Office

18F-5, 55 Chung Cheng 3rd Road, Kaohsiung 800, Taiwan

Phone: +886-7-2239425 Fax: +886-7-2239122

##### PT.TMEIC Asia Indonesia

Unit-E, 23rd floor Alamanda Tower, Jl. TB Simatupang Kav 23-24

Cilandak Barat, Jakarta 12430

Phone: +62-21-2966-1699 Fax: +62-21-2966-1689

##### TMEIC Asia (Thailand) Co., Ltd.

Unit 12A03, 12A Fl., AIA Capital Center,

89 Ratchadapisek Road, Dindaeng, Bangkok 10400 Thailand

Phone: +66-2045-0512 Fax: +66-2045-0517

##### TMEIC Industrial Systems India Private Limited

The Millenia, Tower'A', 10th Floor, # 1&2 Murphy Road,

Halasuru, Bangalore, India - 560 008

Phone: +91-80-6751-5599 Fax: +91-80-6751-5550

##### Hyderabad Branch Office

Unit No.#03-01, Level 3, Third Floor, Block 2, Cyber Pearl,

HITEC City, Madhapur, Hyderabad, Telangana 500081, India

Phone: +91-40-44340000 Fax: +91-40-44340034

##### Mumbai Branch Office

901/D, Filix, L.B.S Road, Opp Asian Paints,

Bhandup-West Mumbai-400078

Phone: +91-22-61555444 Fax: +91-22-61555400

### Overseas Office

#### Middle East

##### Middle East Branch

Office No. 5EB-533, 5th Floor, 5EB, Dubai Airport Freezone,

P. O. Box 54512, Dubai, United Arab Emirates

Phone: +971-4-6091-434 Fax: +971-4-6091-439

## To users of our inverters:

### PRECAUTIONS

- Read the entire "Instruction Manual" carefully for important information about safety, handling, installation, operation, maintenance, and parts replacements.
- When using our inverters for equipment such as nuclear power control equipment, aviation and space flight control equipment, traffic equipment, and safety equipment, and there is a risk that any failure or malfunction of the inverter could directly endanger human life or cause injury, please contact our headquarters, branch, or office printed on the front and back covers of this catalogue. Such applications must be studied carefully.
- When using our inverters for critical equipment, even though the inverters are manufactured under strict quality control, always fit your equipment with safety devices to prevent serious accident or loss should the inverter fail (such as failure to issue an inverter trouble signal).

- TMdrive is a trademark of Toshiba Mitsubishi-Electric Industrial Systems Corporation
- DeviceNet is a registered trademark of ODVA (Open Device Net Vender Association Inc.)
- ProfiBus is a registered trademark of PROFIBUS User Organization.
- Modbus is a registered trademark of Schneider Electric
- TC-net is trademarks of Toshiba Corporation
- MELPLAC is a trademark of Toshiba Mitsubishi-Electric Industrial Systems Corporation
- All other registered trademarks are the property of their respective companies.
- All specifications in this document are subject to change without notice.